

Table of contents

	Page
Introduction	G2

Technical data	G3

Mounting	G4

Electrical connection	G5

Adjustment	G6

Switching logic	G6

Maintenance	G8

Error search	G8

Subject to technical change and price change.

All dimensions in mm (inches).

We assume no liability for typing errors.

Different variations to those specified are possible.

Please contact our technical consultants.

Introduction / Function

Introduction

Fields of application

The unit is used for level monitoring of electrical conductive liquids, muds etc. in all kinds of containers.

Type KN 2700: 1 point level limit switch
 Type KN 2800: 2 point level limit switch

Due to the robust design of the measuring bar, the unit may resist strong mechanical loads.

Use in oily and greasy liquids is not recommended, for this may cause an isolating coat on the measuring bar.

Due to the use of alternate current in the electrical measuring circuit, corrosion and electrochemical reaction is avoided.

Applications

Building materials industry

mortar, mud, concret etc.

Chemical industry

asic, alkaline solution etc.
 (as far as 1.4301, PE, PUR is resistant)

Enviromental technologie

water level , sewage etc.

Approvals

CE	EMC	EN 61326 / A1
	Electrical Safety	EN 61010-1

Function KN 2700

The conductive probe is screwed into the lateral container wall, so that it is level with the filling height to be registered and monitored. Due to the incline measuring bar, the sliding of material from the bar will be increased.

The probe is detecting a liquid by measuring its conductivity. The conductivity between the front of the measuring bar and the container wall will be measured.

Standard in every unit is a signal output delay, which can be adjusted. This causes a secure measurement in moving liquid surfaces.

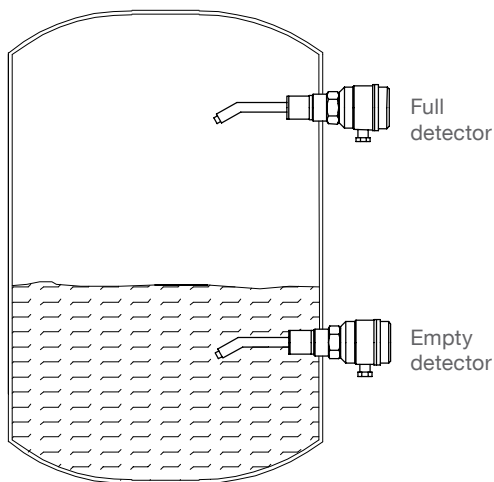

Function KN 2800

The conductive probe is screwed into the upper container wall. The ends of the measuring bars are level with the filling heights to be registered and monitored.

The probe is detecting a liquid by measuring its conductivity.

The conductivity between the end of the measuring bars and the container wall (2 bar unit) or the ground-bar (3 bar unit) will be measured.

If the liquid level is higher than the maximum-bar, the output signal signs „full“, if it is lower than the minimum-bar, it signs „empty“. If the level is between the bars, the output signal remains on the last state.

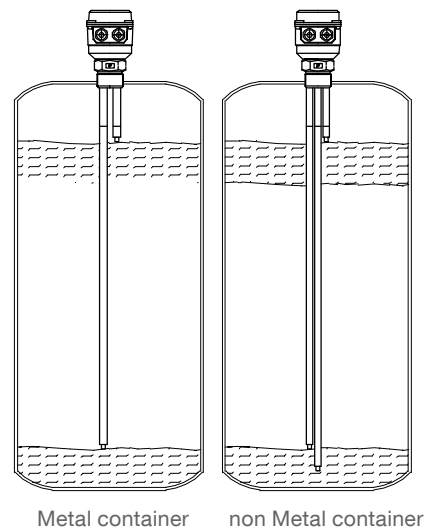

Technical data

Dimensions

For detailed dimensions see price list

Mechanical data

Housing:	Aluminium diecast housing RAL 5010 gentian blue
Enclosure:	IP 66 to EN 60529
Screwed piece: Material:	Stainless steel 1.4301/304;1.4305/303 Isolation PE / PUR
Width across:	50mm
Thread:	G 1 1/2" ISO 228 NPT 1 1/2" conical ANSI B1.20.1
Overall weight:	approx. 1.2 kg
Options:	Weather protection cover

Operating conditions

Operating temperatures: see drawing below

Features of material:Conductive material, which has no strong propensity to cake or deposit and leave no coat of oil or grease on the measuring bar

max. Probe load: KN 2700: max. 500N laterally
(at the front of the bar)
KN 2800: max. 100Nm laterally

max. Container pressure: 0.8 bar

in case of high mech. loading: Mounting of an protective angle above the probe

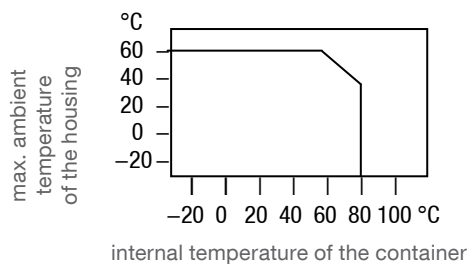

Electrical data

Mains voltage:	alternative 220-240V / 110-120V / 42V / 24V +10% -15% 50/60 Hz
	20V - 30V DC max. ripple: 7 VSS
Installed load:	max. 2 VA AC max. 2W DC
Connection terminal:	max. 2.5mm ²
Screwed cable gland:	M20x1.5 cable gland NPT 1/2" conduit
Signal output:	potential-free relay point: AC max. 250V, 2A, 500VA at cosφ= 1 DC max 300V, 2A, 60W
Switch status display:	by built-in LED
Signal delay:	probe free -> covered approx. 0.5 sec. probe covered -> free adjustable approx. 0.5..6 sec. (only KN 2700) (other times on request)
Safety operation:	to be switched over for (FSL, FSH) minimum / maximum security
Sensitivity:	continuously variable setting range I (5k) approx. 500 - 4500W range II (50k) approx. 0.5 - 50kW range I and II switchable
Measuring voltage:	approx. 6V / 60 Hz potential-free to mains voltage Isolating 3kV DC
Isolating:	Mains voltage to signal output: 3kV~
Protection class:	I

Mounting

Mounting KN 2700

For optimal function, connect the external terminal of the probe with a wire to the container wall. This is especially recommended, if there is no lasting electrical connection between the thread of the probe and the container wall.

To screw the device in, use a 50mm open-end wrench (do not turn the housing).

The screwed cable gland must face downwards. This ensures that,

- a.) no water enters into the housing through the screwed cable gland
- b.) the front of the measuring bar faces downwards, to improve the sliding of material from the bar

To improve furthermore the sliding of material from the bar, it is possible to mount the probe in an oblique position (upto 30°).

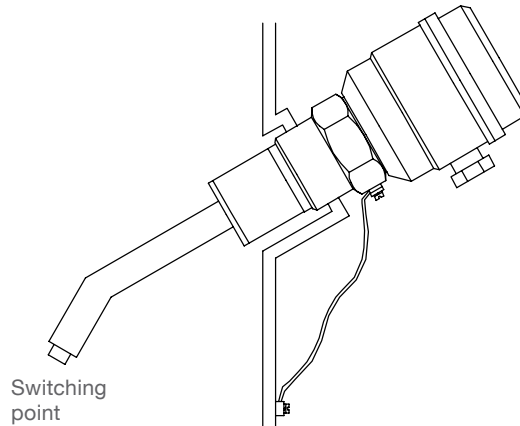

Mounting KN 2800

Extend the measuring bars to the desired length.

Make sure, that ground bar, maximum bar and minimum bar are not interchanged (see picture).

To screw the device in, use a 50mm open-end wrench (do not turn the housing).

Make sure that the screwed cable gland safely seals the cable and that it is tight (danger of water intrusion).

- Make sure, that no conductive material can rest between
- the unisolated parts of the measuring-bars and the container wall
 - between the unisolated parts of the measuring-bars. This may cause malfunction.

For metal container wall:

Ground bar is not necessary (version with 2 bars). For optimal function connect the external terminal of the probe with a wire to the container wall. This is especially recommended if there is no lasting electrical connection between the thread of the probe and the container wall.

For non metal container wall:

Ground bar is necessary. It should be longer than the minimum bar. An electrical connection between the external terminal of the probe and the container wall is not necessary.

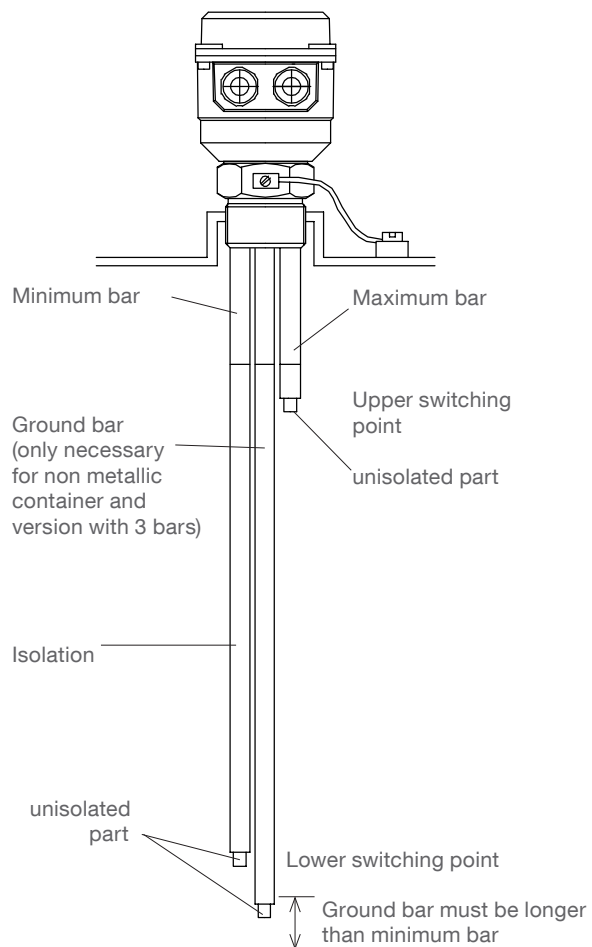

Electrical connection

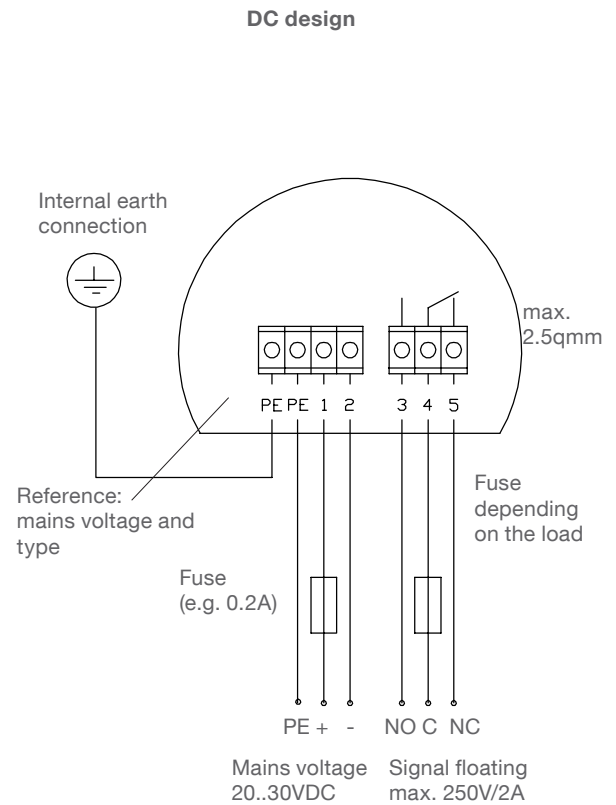
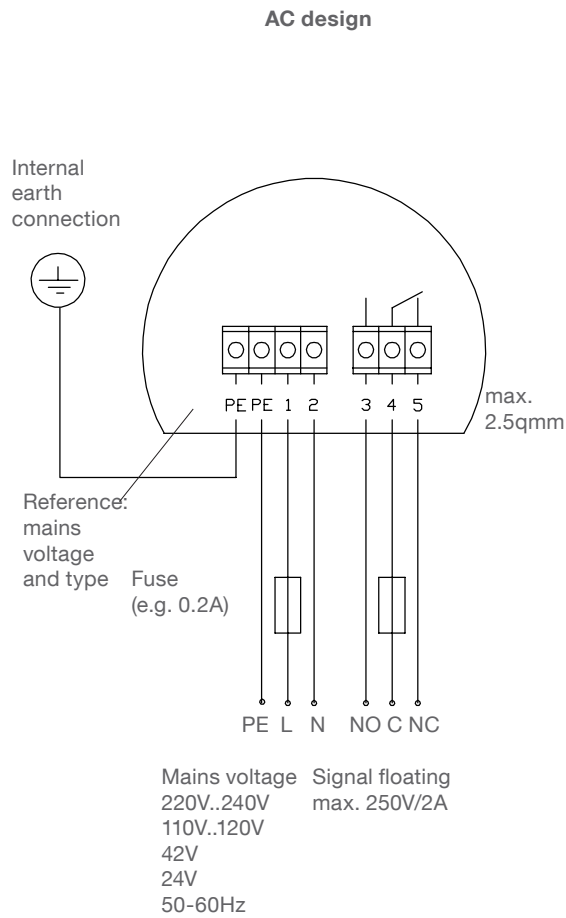

Safety instructions

For terminal connection of the device the local regulations or VDE 0100 (Regulations of German Electrotechnical Engineers) must be observed

- Provide protection for relay contacts and output transistors to protect the device against spikes with inductive loads.
- Compare the mains voltage applied with the specifications given on the electronic module before switching the device on.
- Make sure that max. 8mm of the pigtailed are bared (danger of contact with live parts).
- Make sure that the boots for protecting cable terminations are not longer than 8mm (danger of contact with live parts).
- Make sure that the screwed cable gland safely seals the cable and that it is tight (danger of water intrusion).
- A voltage-disconnecting switch must be provided near the device.
- In the case of inexpert handling or handling malpractice, the electric safety of the device cannot be guaranteed.
- In the case of a defect, the distribution voltage must automatically be cut off by a RCCB protection switch to protect the user of the device from indirect contact with dangerous electric tensions.

Adjustment / Switching logic

Adjustment

- LED „power“: permanent „on“ with mains voltage
- LED „signal“: „on“ if relaiscoil is idle
- Adjusting device „delay“: adjustment of signal output delay if the probe gets free (covered -> free). (only KN 2700) (delaytime approx. 0.5 .. 6 sec.)
- Range switch and adjusting device „sensitivity“: adjustment to the conductivity of the measured liquid
- strong conductivity liquid:
range switch 5k -> adj. device 5k
- less conductivity liquid:
range switch 50k -> adj. device 50k
- adjustment device:
left stop position -> less sensitivity
right stop position -> more sensitivity

Adjust the sensitivity in the way that a secure switching by covering and getting free of the probe is guaranteed. If a deposit of the liquid on the measuring bar of the probe is expected, adjust the probe more in the direction „less sensitivity“.

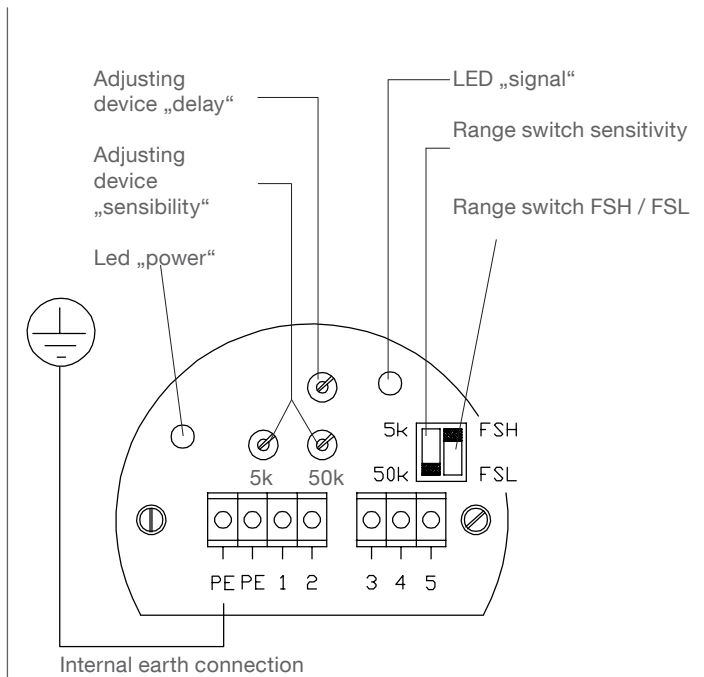

Switching logic KN 2700

Switch FSL / FSH:

Switch between maximum- and minimum-safety level.

If the probe is used to indicate full load:
 -> set to maximum safety level FSH
 Power failure or line break is regarded as „full“ signal (protection against overcharging).

If the probe is used to indicate empty load:
 -> set to minimum safety level FSL
 Power failure or line break is regarded as „empty“ signal (protection against running dry).

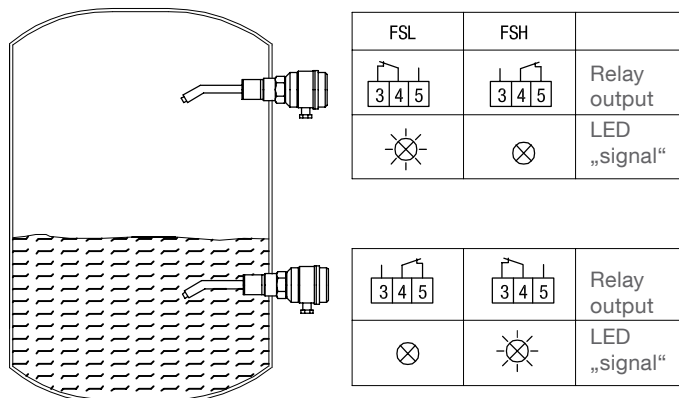

Switching logic

Switching logic KN 2800

Range switch FSL / FSH: see remarks at „switching logic KN 2700“

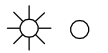
	= Relais output
	= LED „signal“

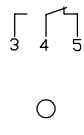
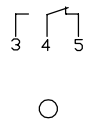
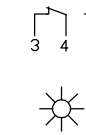
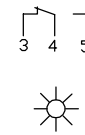
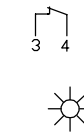
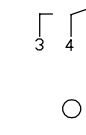
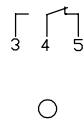
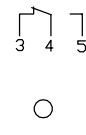
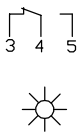
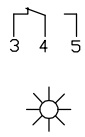
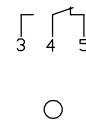
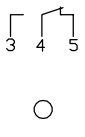
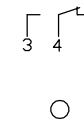
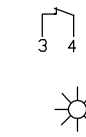
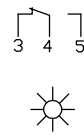
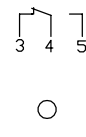
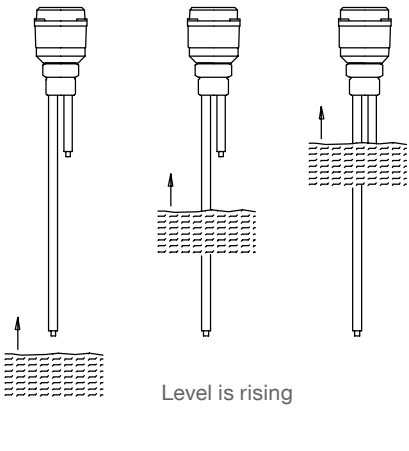
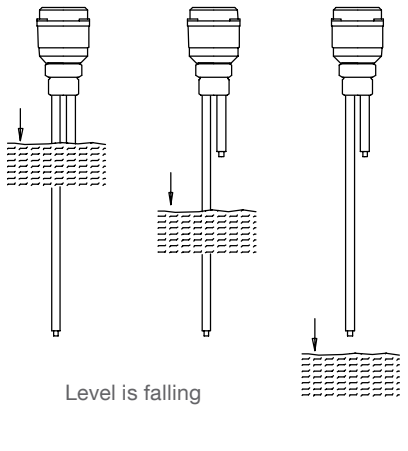
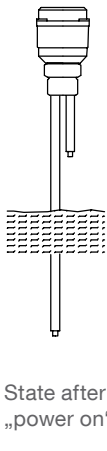
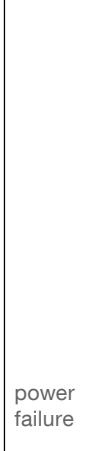
FSL								
FSL								
								

Maintenance / Error search

Maintenance

Normally the device requires no maintenance. However, in extreme fields of application like the industry of building materials occasional cleaning of the probe is recommended.

Changing the electronic module

1. Open the housing lid and remove the pigtails from the device.
2. Disconnect internal wire for earth connection from terminal PE.
3. Unscrew the two fastening screws of the electronic module.
4. Pull out electronic module.
5. Remove wires from the electronic module.
6. Connect wires to the new electronic module (see figure right hand).
7. Insert new electronic module.
8. Fix internal wire for earth connection to terminal and screw down the fastening screws. Connect the pigtails to the device.
9. Adjust the probe.

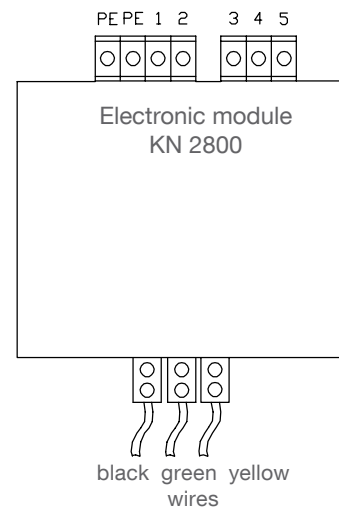
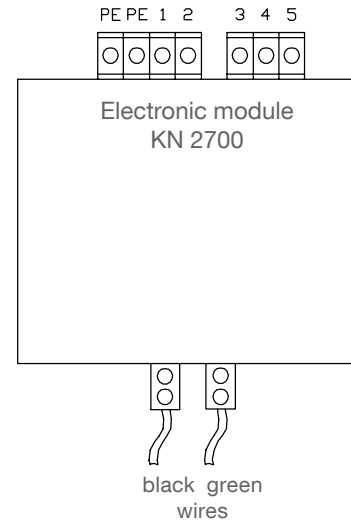

Error search

If the probe does not work satisfactory check following items:

1. Is there a conductive coat between the front of the measuring bar and the container wall?
if yes, clean the probe or decrease the sensitivity
2. Is there a non conductive coat at the front of the measuring bar (oil, grease)?
if yes, clean the probe or increase the sensitivity
3. Is the sensitivity adjusted so the probe switches if it gets free and covered?
if not, adjust the sensitivity

If point 1 to 3 are failing:

4. Remove the probe from the container and clean it. Cause a short circuit between the front of the measuring bar and the thread. Does the signal output switch?
if no, probe is defect
if yes, contact manufacturer